

EZSET[®] RESIDENTIAL



Always Striving.
philhardware.com



New

The IP/IS Series Interconnected Lock is a new addition to our contemporary locks. They are designed to fit with ADA requirements.

Security Features

200B Series ANSI Grade 3 Certified Deadbolt (ANSI/BHMA A156.5-2001) for Auxiliary Lock and Associated Products Product meets and exceeds ANSI Grade 3 requirements for auxiliary locks

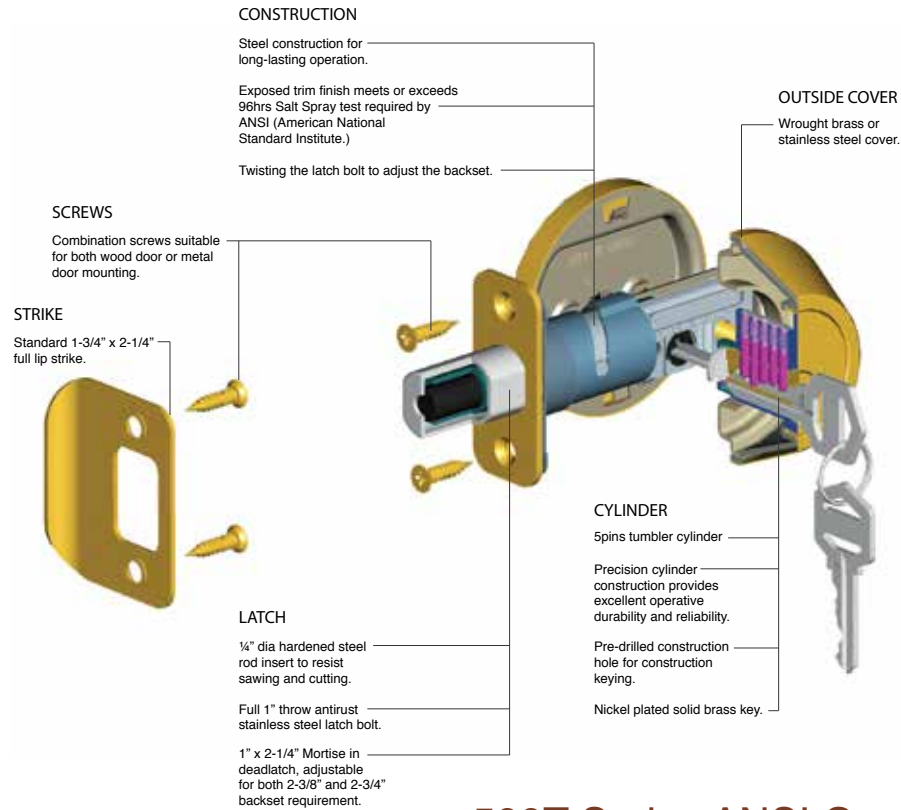

500T Series ANSI Grade 3 Certified Leverset (ANSI/BHMA A156.2-2003) for bored & preassembled locks & latches Product meets and exceeds ANSI Grade 3 requirements for single-point locks and latches

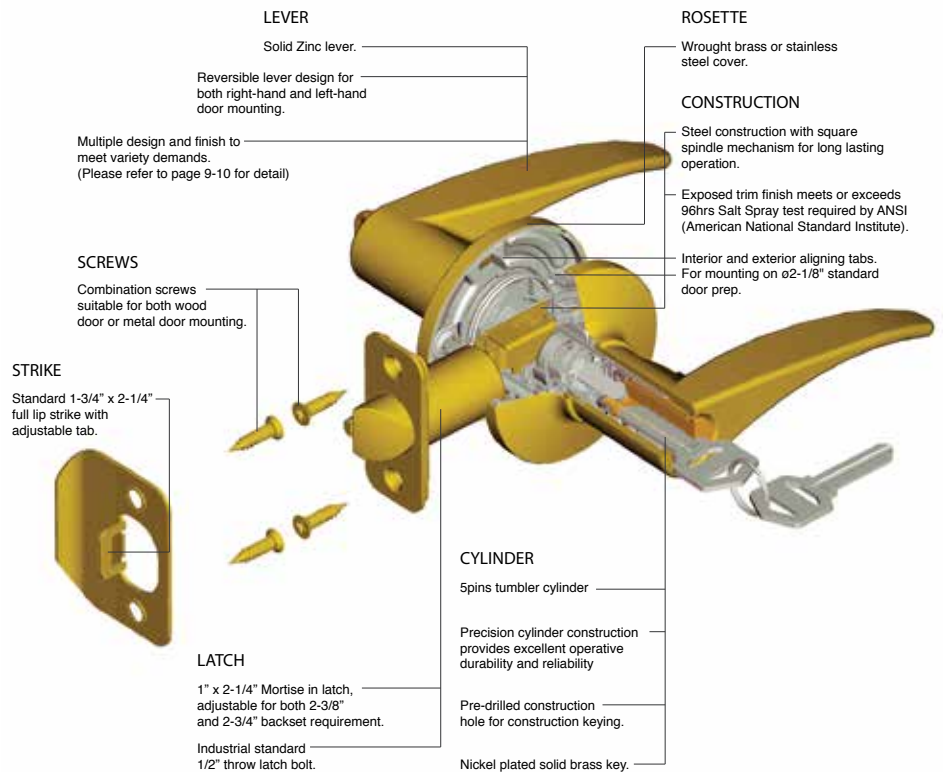

Contemporary Design

KELLINGTON HANDLESET

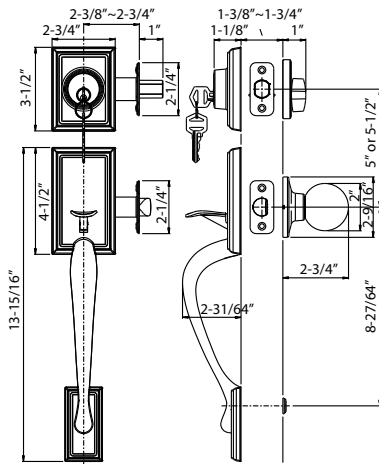

KELLINGTON (KN)
US15

AM SERIES LEVER



HOLLYWOOD (HW)
US15

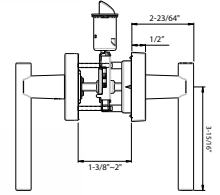

SOHO RC (SH) US26
Round Rosette

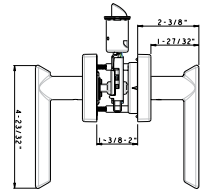

SOHO SQ (SH) US15
Square Rosette

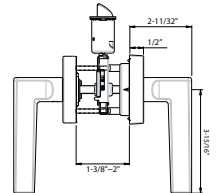

AUSTIN (AT)
US26

FINISHES



US15
Satin Nickel



US26
Polish Chrome



US26D
Satin Chrome
(Soho & Deadbolt only)

Interconnected

ENTRANCE HANDLESETS



CHATEAU (CH)
US10B

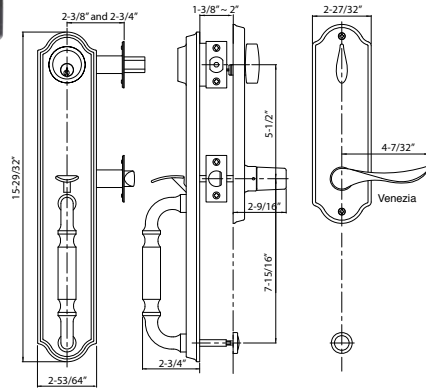

NEW!
FAIRMONT (FT)
US15

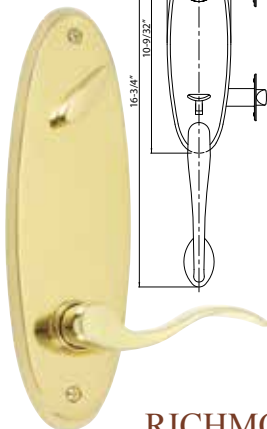
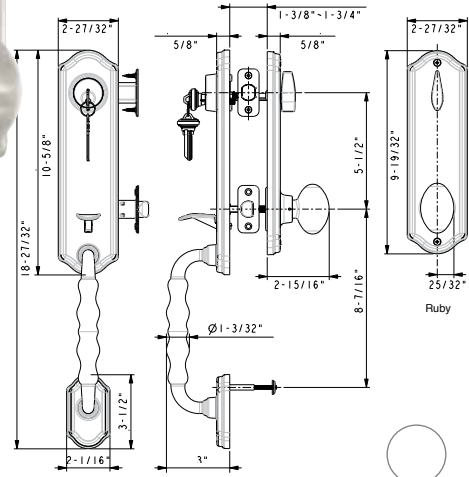

RICHMOND (RI)
PVD

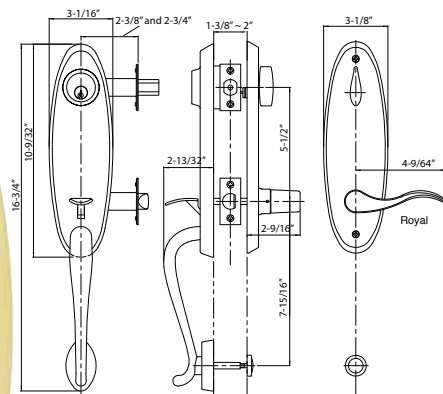

HAMPTON (HA)
US12P

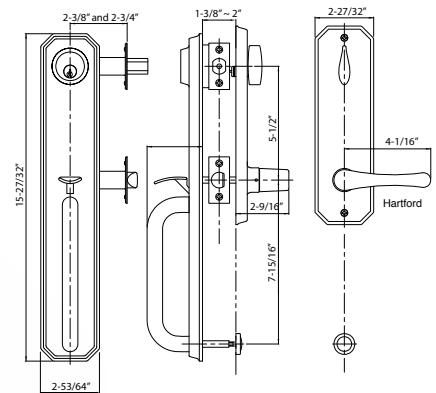

Solid Brass

500TB SERIES LEVERSETS

ANSI Grade 3



HARTFORD (HD)
US12P

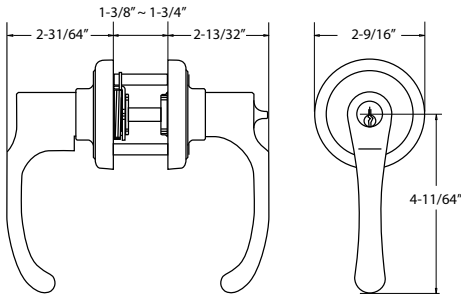
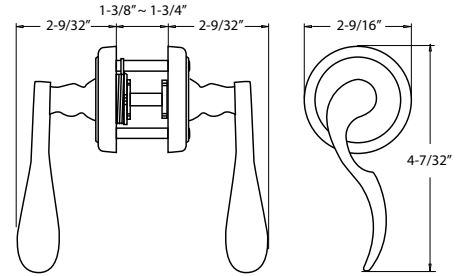

FASCINITE (FE)
US15A



LAFAYETTE (LA)
US15

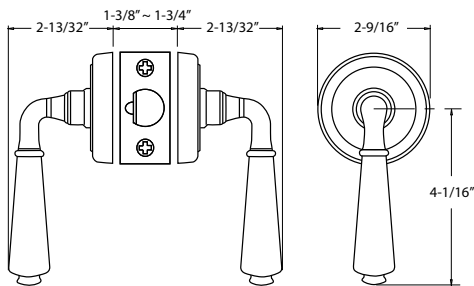
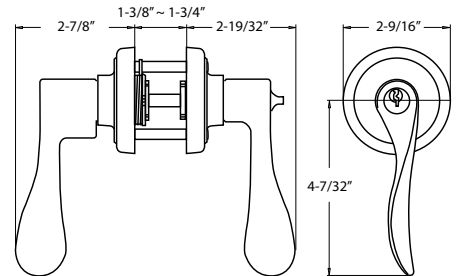

VENEZIA (VA)
US10B

Interconnected

IL SERIES



300IL-SD
San Diego (SD) Lever
US15



301IL-CT
Charlotte (CT) Lever
US15



300IL-RY
Royal (RY) Lever
US15



Mounting without
Exterior Escutcheon Plate

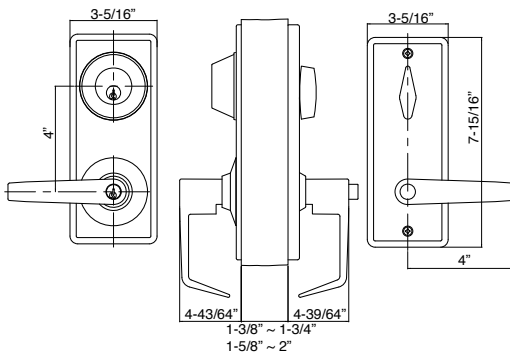

ANSI Grade 2

IZ SERIES



NEW!

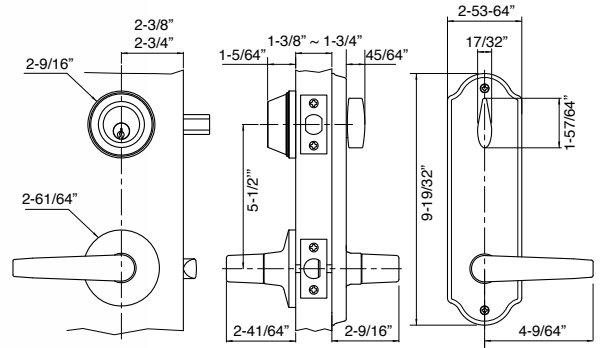
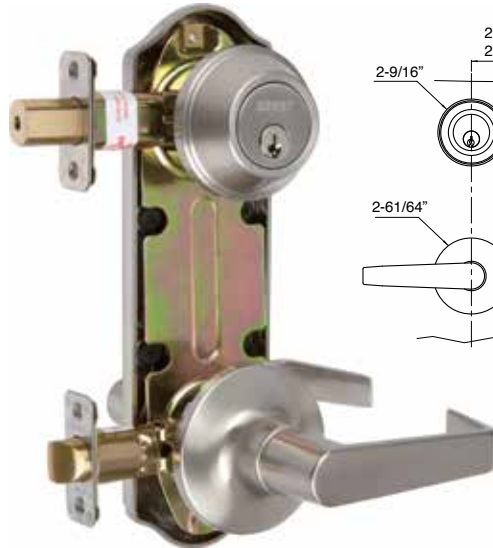

301IZ-CT
Charlotte (CT) Lever
US15

301IZ-CT-US15
Charlotte (CT) Lever

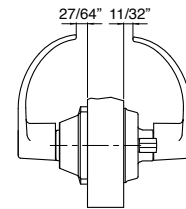
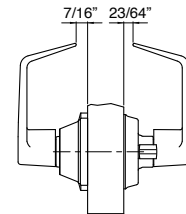

301IZ-SD-US15
San Diego (SD) Lever

INTERIOR APPLICATION



South Bay



Escort



Handlesets & Levers

400 SERIES HANDLESETS



MAYFAIR (MA)
US10B



IMPERIAL (IM)
US15



KELLINGTON (KN)
US12P



500T SERIES LOCKSETS



ROYAL (RY)
US10B



MANHATTAN (MH)
US5



ESCORT (ET)
US3



PALMER (PA)
US26



SHELBY (SY)
US12P

Lever Design **ANSI Grade 3**
500T SERIES LOCKSETS



Knob Design
100T SERIES LOCKSETS



ESCUTCHEON PLATE
5" CENTER TO CENTER



US3

Deadbolt

200B SERIES



SINGLE CYLINDER
US3



DOUBLE CYLINDER
US3



ONE SIDED (Full Bore)
US32D



ONE SIDED (Half Bore)
US32D

Sliding

DOOR LOCK

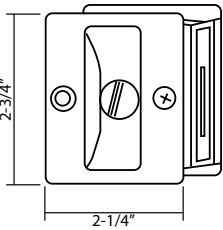

US3
Passage



US15
Privacy

SPECIFICATIONS

Door Prep
Door Fitting
Exposed Trim
Strike

2-1/4" H x 1-3/4" W notch.
1-3/8" ~ 1-3/4" door thick.
Brass, stainless steel, or zinc alloy.
1" x 2-1/4" rectangular.

NEW!

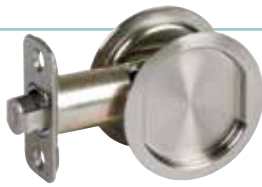

US15
Passage



US15
Privacy

Fits 2-1/8" cross bore
2-3/8" fixed
backset latch

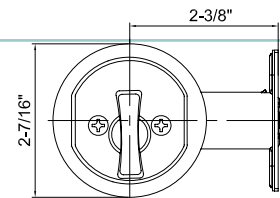

FINISHES



PVD
Lifetime



US3
Polish Brass



US5
Antique Brass



US10B
Oil Rubbed Bronze



US12P
Tuscany Bronze



US15
Satin Nickel



US15A
Pewter



US26
Polish Chrome

Not all styles available in all finishes. See finish chart on page 12 for details.

Finish

AVAILABILITY

SERIES	ITEM	Abbrev	PVD	US3	US5	US10B	US12P	US15	US15A	US26	US26D	US32D
			505	605	609	613		619	620	625	626	630
Interconnected Handleset and Solid Brass Levers												
400 Interconnected	CHATEAU (CH)		●			●	●	●	●	●		
	FAIRMONT (FT)		●			●	●	●	●	●		
	HAMPTON (HA)		●			●	●	●	●	●		
	RICHMOND (RI)		●			●	●	●	●	●		
500TB Solid Brass	FASCINITE (FE)			●		●	●	●	●	●		
	HARTFORD (HD)			●		●	●	●	●	●		
	LAFAYETTE (LA)			●		●	●	●	●	●		
	VENEZIA (VA)			●		●	●	●	●	●		
Handleset, Interconnected Lock, Levers, Knob, Deadbolt and Combo Pack												
400 2PC Type	IMPERIAL (IM)		●	●	●	●	●	●	●	●		
	KELLINGTON (KN)					●	●	●	●	●		
	MAYFAIR (MA)			●		●	●	●	●	●		
500T	CAMBER (CM)					●	●	●	●	●		
	ESCORT (ET)			●	●	●	●	●	●	●		
	JURAN (JU)			●		●	●	●	●	●		
	MANHATTAN (MH)			●	●	●	●	●	●	●		
	PALMER (PA)			●		●	●	●	●	●		
	ROYAL (RY)		●	●	●	●	●	●	●	●		
	SHELBY (SY)					●	●	●	●	●		
300IL 4"CTC					●		●					
300IZ 5-1/2"CTC							●					
200B	DEADBOLT		●	●	●	●	●	●	●	●	●	●
100T	BALA (BA)			●	●	●	●	●	●	●		●
	GUARDIAN (GN)			●	●	●	●	●	●	●		●
	OLYMPUS (OS)			●	●	●	●	●	●	●		●
	RUBY (RB)			●	●	●	●	●	●	●		●
300T/310T Combo				●	●						●	
Contemporary Interconnected Lock, Levers and Deadbolt												
500AM	AUSTIN (AT)							●		●		
Contemporary	HOLLYWOOD (HW)							●		●		
	SOHO (SH)							●		●	●	
301IP 5-1/2" CTC							●		●			
301IS 5-1/2" CTC							●		●			
200TS	DEADBOLT							●		●		
200TR	DEADBOLT							●		●		

● Product available in stock. Please refer to price book for details. Other finishes may be available upon request. Please allow longer lead time, min. 300 lock order.

Accessories

Lock Strikes



9101
1-1/8" x 2-3/4"
"T" type with tab



9102
1-3/4" x 2-1/4"
Full lip with tab square corner



9103
1-3/4" x 2-1/4"
Full lip with tab 1/4" radius round corner



9108
1-3/4" full round with tab for tubular type drive-in latch



9125
1-1/4" x 2-3/4"
"T" type adjustable

Deadbolt Strikes



9111
1-1/8" x 2-3/4"
Rectangular square corner



9112
1" x 2-1/4"
Rectangular square corner



9113
1" x 2-1/4"
Rectangular 1/4" radius round corner



9117
1-3/4" x 2-1/4"
Full lip 1/4" radius round corner



9119
1-1/4" x 3-5/8"
Security strike 1/4" radius round corner

Keys



TE5



HK5

KW1 5-Pins



SC5

SC1 5-Pins



HK6



SC6

SC4 6-Pins



9301-K
KW1



9301-S
SC1 & SC4



Accessories

Dead Latches for 100T Entrance

Optional: 9071 square corner

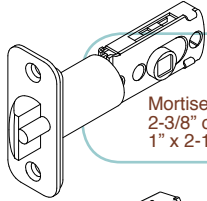

9073

Mortise Dead Latch
2-3/8" or 2-3/4" adjustable backset
1" x 2-1/4" Round Corner Faceplate

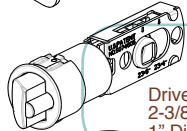

9075

Drive-in Dead Latch
2-3/8" or 2-3/4" adjustable backset
1" Diameter

D904



Dead latch drive-in cap for converting mortise latch to Drive-in Latch

Spring Latches for 101T, 102T, 501TZ, 502TZ

Optional: 9072 square corner

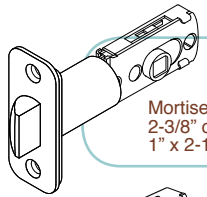

9074

Mortise Spring Latch
2-3/8" or 2-3/4" adjustable backset
1" x 2-1/4" Round Corner Faceplate

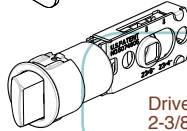

9076

Drive-in Spring Latch
2-3/8" or 2-3/4" adjustable backset
1" Diameter

D907



Spring latch drive-in cap for converting mortise latch to Drive-in Latch

Dead Latches for 500TZ Entrance

Optional: 9045 square corner

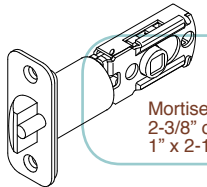

9045R

Mortise Dead Latch
2-3/8" or 2-3/4" adjustable backset
1" x 2-1/4" Round Corner Faceplate

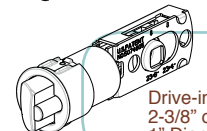

9045C

Drive-in Dead Latch
2-3/8" or 2-3/4" adjustable backset
1" Diameter

D924



Dead latch drive-in cap for converting mortise latch to Drive-in Latch

Dead Latches for 500TB Entrance

Optional: 9050 square corner
9050UL UL square corner
9050RUL UL round corner

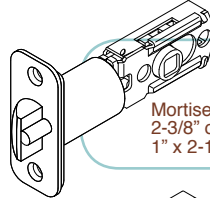

9050R

Mortise Dead Latch (Brass Bolt)
2-3/8" or 2-3/4" adjustable backset
1" x 2-1/4" Round Corner Faceplate

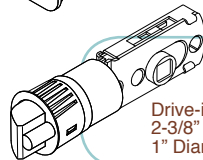

9050C

Drive-in Dead Latch (Brass Bolt)
2-3/8" or 2-3/4" adjustable backset
1" Diameter

Spring Latches for 400 Interconnected Handleset (RI/CH/HA/FT), 501TB, 502TB, and 400 Handleset (MA/IM/KN) with Solid Brass lever (VA/HD/FE/LA)

Optional: 9079 square corner
9079UL UL square corner
9079RUL UL round corner

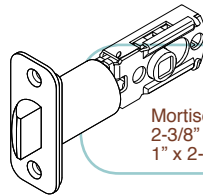

9079R

Mortise Spring Latch (Brass Bolt)
2-3/8" or 2-3/4" adjustable backset
1" x 2-1/4" Round Corner Faceplate

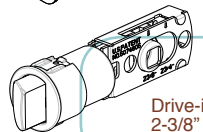

9079C

Drive-in Spring Latch
2-3/8" or 2-3/4" adjustable backset
1" Diameter

D927



Spring latch drive-in cap for converting mortise latch to Drive-in Latch

Latches for 200B

Optional: 9091 square corner
9091UL UL square corner
9092UL UL round corner

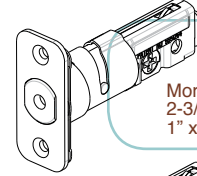

9092

Mortise Deadbolt Latch
2-3/8" or 2-3/4" adjustable backset
1" x 2-1/4" Round Corner Faceplate

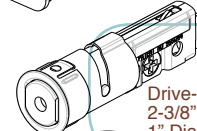

9093

Drive-in Deadbolt Latch
2-3/8" or 2-3/4" adjustable backset
1" Diameter

D909



Deadbolt latch drive-in cap for converting mortise latch to Drive-in Latch

Spring Latches for 400 Handleset (MA/IM/CA/KN)

Optional: 9080 square corner
9080UL UL square corner
9080RUL UL round corner

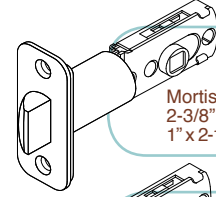

9080R

Mortise Spring Latch
2-3/8" or 2-3/4" adjustable backset
1" x 2-1/4" Round Corner Faceplate

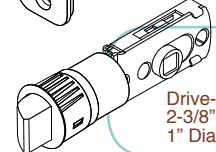

9080C

Drive-in Spring Latch
2-3/8" or 2-3/4" adjustable backset
1" Diameter

Spring Latches for AM Series (SH/HW/AT)

Optional: G90A3T square corner

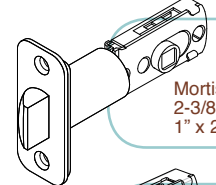

G90A3R

Mortise Spring Latch
2-3/8" or 2-3/4" adjustable backset
1" x 2-1/4" Round Corner Faceplate

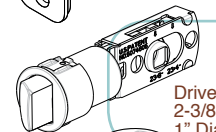

G90A3C

Drive-in Spring Latch
2-3/8" or 2-3/4" adjustable backset
1" Diameter

D927



Spring latch drive-in cap for converting mortise latch to Drive-in Latch

Parts

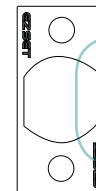

9782

4-way plate is available for converting drive-in latch to 1" x 2-1/4" square mortise latch.

Functions

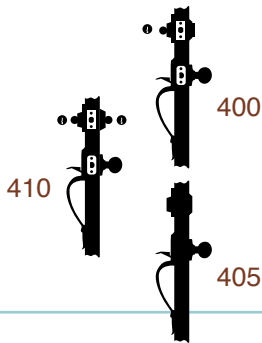

400 Series Handleset – ANSI A156.2, Series 4000, Grade 3

400 Single Cylinder Handleset

Deadbolt thrown or retracted by key from outside or by inside turnpiece. Latch retracted by thumbpiece from outside or by inside knob/lever.

400 Single Cylinder Interconnected Handleset (ANSI F102)

Deadbolt thrown or retracted by key from outside or by inside turnpiece. Latch retracted by thumbpiece from outside or by inside knob/lever. Both deadbolt and latch bolt are retracted to unlocked position by operating inside lever.

410 Double Cylinder Handleset

Deadbolt thrown or retracted by key from either side. Latch retracted by thumbpiece from outside or by inside knob/lever.

405 Dummy Handleset

For use as door pull or as dummy trim on inactive leaf of double door. Fixed thumbpiece and inside knob/lever. Dummy cylinder with inside plate.

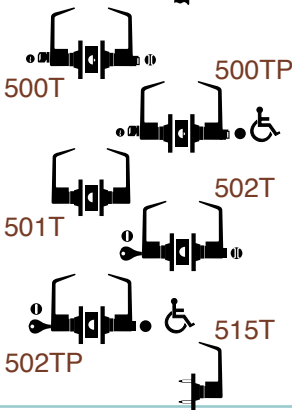

500T Series Lever Lock – ANSI A156.2, Series 4000, Grade 3

500T Entrance

Turn button lock/unlock outside lever. Key lock/unlock from outside.

500TP Entrance (Push Button)

Push inside button locks outside lever. Key lock/unlock from outside. Unlock by push down inside lever.

501T Passage

Both levers always unlocked.

502T Privacy

Turn inside button locks outside lever. Can be opened from outside using outside turn mechanism.

502TP Privacy (Push Button)

Turn inside button locks outside lever. Can be opened from outside using outside turn mechanism. Unlock by push down inside lever.

515T Dummy

Dummy trim for one side on door. Used for door pull or matching inactive trim.



100T Series Knob Lock – ANSI A156.2, Series 4000, Grade 3

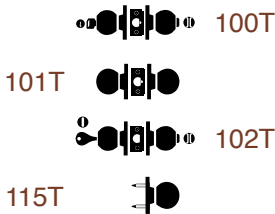

100T Entrance

Turn button lock/unlock outside knob. Key lock/unlock from outside.

101T Passage

Both knobs always unlocked.

102T Privacy

Turn inside button locks outside knob. Can be opened from outside using outside turn mechanism.

115T Dummy

Dummy trim for one side on door. Used for door pull or matching inactive trim.

200 Series Deadbolt Lock – ANSI A156.36, Grade 3

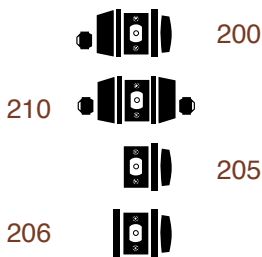

200 Single Cylinder

Deadbolt thrown or retracted by key from outside or by inside turnpiece.

210 Double Cylinder

Deadbolt thrown or retracted by key from either side.

205 One-sided Half-Bore

Deadbolt thrown or retracted by thumbpiece from inside.

206 One-sided Full-Bore

Deadbolt thrown or retracted by thumbpiece from inside. Cover plate outside.

300 Series Interconnected Locks – ANSI A156.12, Grade 3

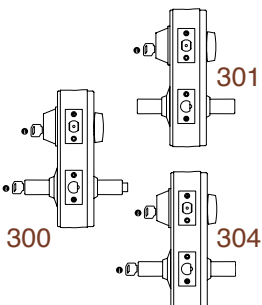

301 Entrance Single Locking, ANSI F95

Latch bolt operated by lever from either side. Deadbolt operated by turn from inside or key from outside. Operating inside lever retracted both deadbolt and latch bolt.

300 Entrance Double Locking, ANSI F97

Deadbolt operated by key from outside or by turnpiece inside. Deadlatch is locked by key from outside or by push button from inside. Turn inside lever to release deadbolt and latchbolt simultaneously for immediate exit. Latch deadlocks when door is closed.

304 Storeroom Double Locking, ANSI F98

Deadbolt operated by key from outside or by turnpiece inside. Outside lever is fixed, entrance by key only. Turn inside lever to release deadbolt and latchbolt simultaneously for immediate exit. Latch deadlocks when door is closed.



DISTRIBUTION BY:



Philadelphia Hardware Group Inc.

SAN DIEGO DISTRIBUTION CENTER

(Home Office)
6590 Top Gun Street
San Diego, CA 92121
Tel: (858) 642-0450
Fax: (858) 642-0454
Toll Free Tel: 1-800-545-2309
Toll Free Fax: 1-800-828-0988
www.philihardware.com

CHICAGO DISTRIBUTION CENTER

3687 Darlene Court
Aurora, IL 60504
Toll Free Tel: 1-800-545-2309

ATLANTA DISTRIBUTION CENTER

2319 Defoor Hills Road N.W.
Atlanta, GA 30318
Toll Free Tel: 1-800-545-2309